



Installation instructions, accessories

Volvo Car Corporation Gothenburg, Sweden

Instruction No	Version	Part. No.
30756142	1.1	30756143, 30756144, 30756145, 30756146

Metal pedals

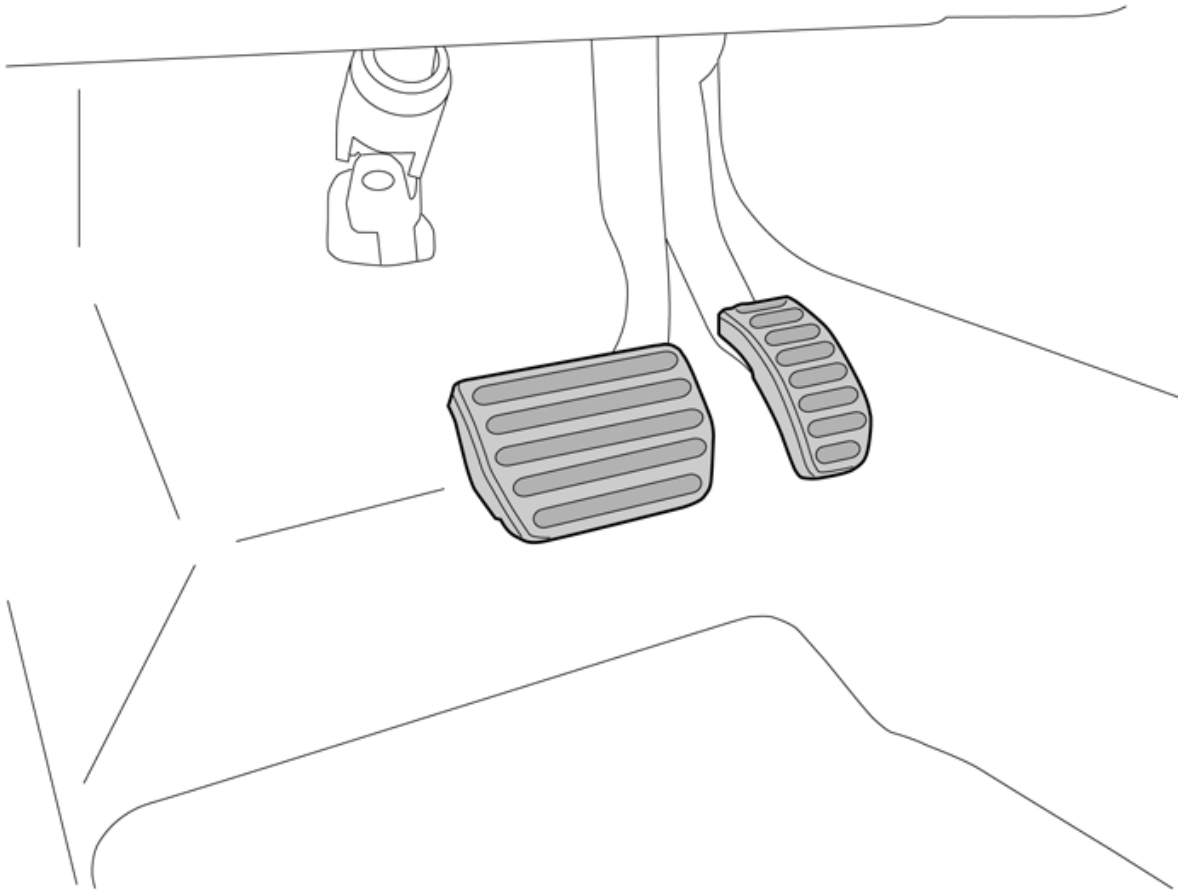

IMG-309463



Installation instructions, accessories

Volvo Car Corporation Gothenburg, Sweden

Equipment



IMG-239667



IMG-309504

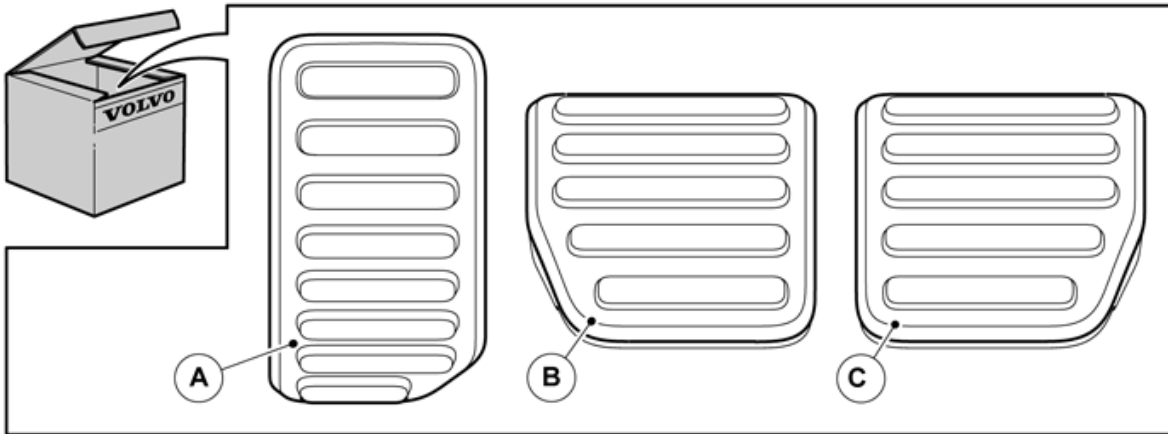
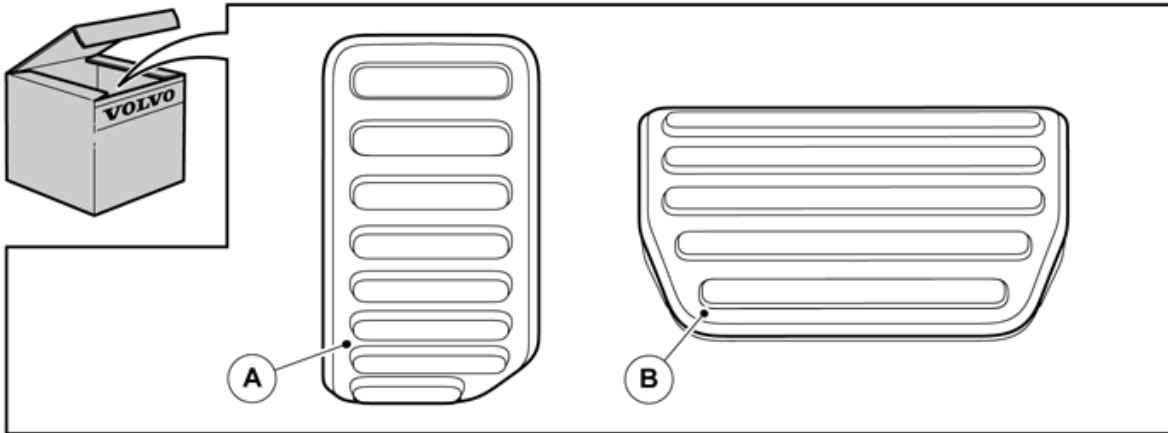

IMG-309483



Installation instructions, accessories

Volvo Car Corporation Gothenburg, Sweden

Any comments on this publication? Please contact your nearest retailer. Thank You!

Publ.no:	Issue:	Kit no:
Comments:.....		
.....		
.....		
.....		

From:	
Address:	
Telephone:	
Telefax:	

IMG-213320



Installation instructions, accessories

Volvo Car Corporation Gothenburg, Sweden

INTRODUCTION

Read through all of the instructions before starting installation.

Notifications and warning texts are for your safety and to minimise the risk of something breaking during installation.

Ensure that all tools stated in the instructions are available before starting installation.

Certain steps in the instructions are only presented in the form of images. Explanatory text is also given for more complicated steps.

In the event of any problems with the instructions or the accessory, contact your local Volvo dealer.

1

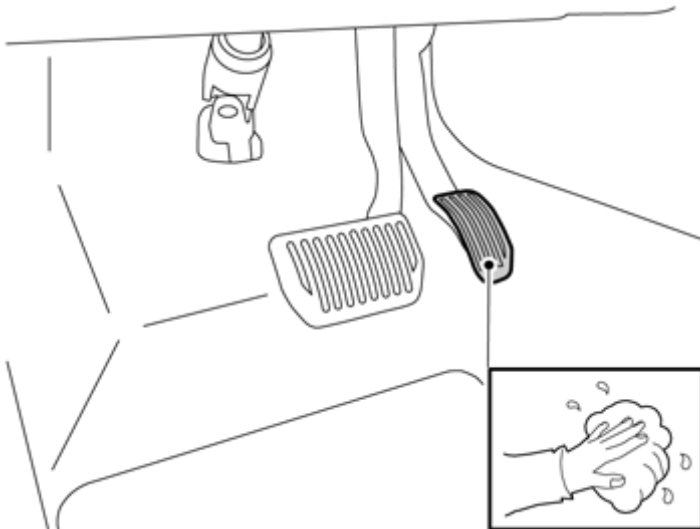

IMG-309523

Clean if necessary.



Installation instructions, accessories

Volvo Car Corporation Gothenburg, Sweden

2

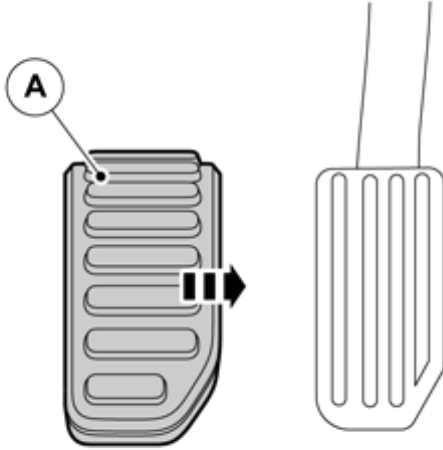

Take the accelerator pedal cover (A) from the kit.

Hook the cover onto the long side of the accelerator pedal.

IMG-309623

3A

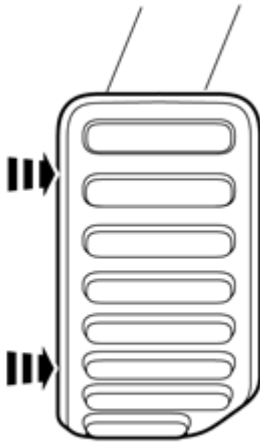

A

Press the cover against the pedal at the same time as folding the cover's edges over using a weatherstrip tool.

Check, using a mirror, that the edges of the cover have covered the pedal.

Pull at the cover and check that it is secure.

B

IMG-309643

3B

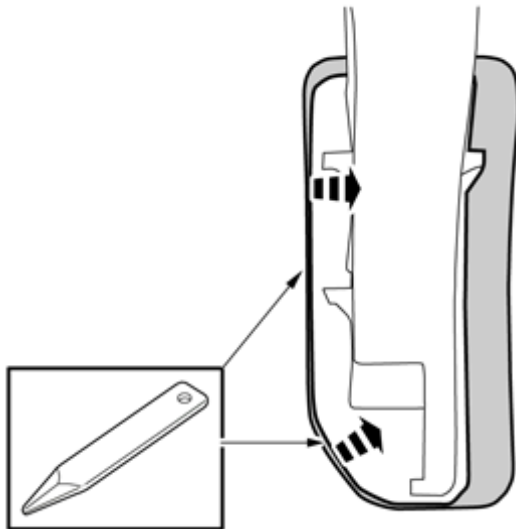

IMG-309664



Installation instructions, accessories

Volvo Car Corporation Gothenburg, Sweden

4

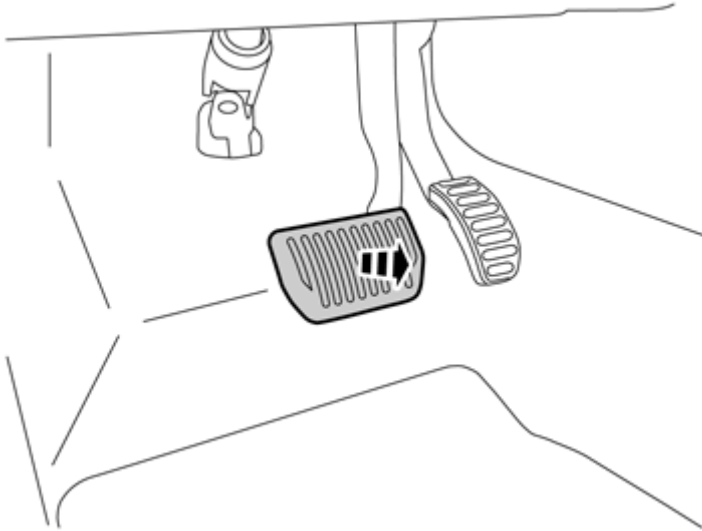

IMG-309665

Applies to cars with an automatic transmission

Remove the pedal cover by grasping at the lower edge and pulling off at the rear edge.

5

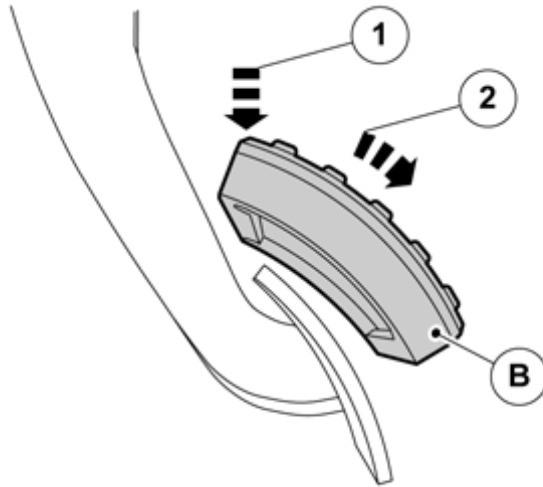

IMG-309666

Take the brake pedal cover (B) from the kit.

Hook the cover on at the upper edge.

6A

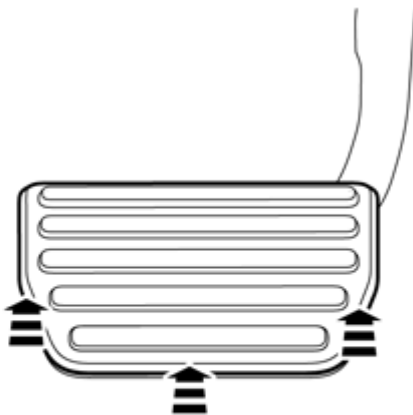

IMG-309667

A

Press the cover against the pedal at the same time as folding the cover's edges over using a weatherstrip tool.

Check, using a mirror, that the edges of the cover have covered the pedal.

Pull at the cover and check that it is secure.

B



Installation instructions, accessories

Volvo Car Corporation Gothenburg, Sweden

6B

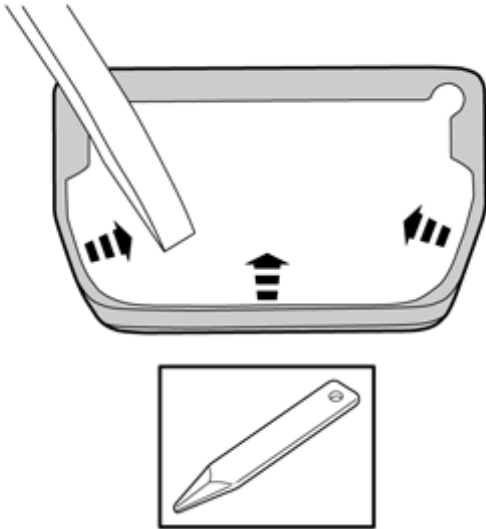

IMG-309668

7

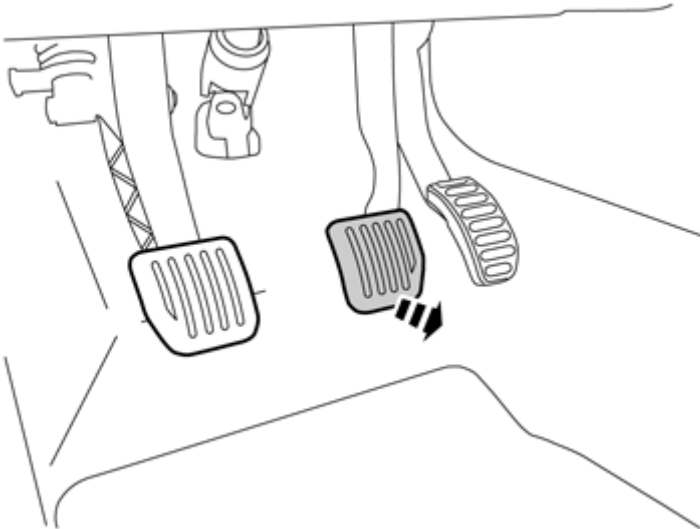

IMG-309669

Applies to cars with manual gearbox

Remove the pedal cover by grasping at the lower edge and pulling off at the lower edge.

8

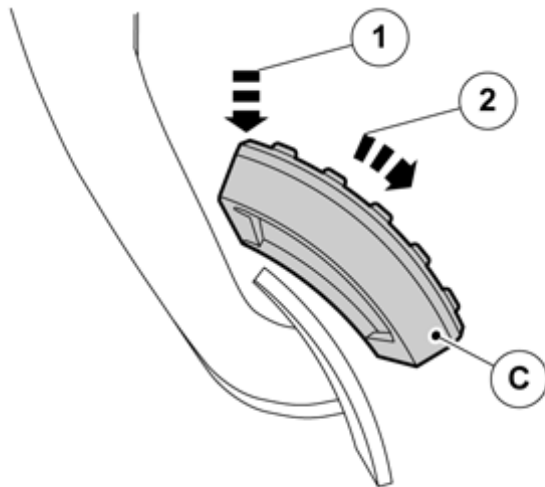

IMG-309670

Take the brake pedal cover (C) from the kit.

Hook the cover on at the upper edge.



Installation instructions, accessories

Volvo Car Corporation Gothenburg, Sweden

9A

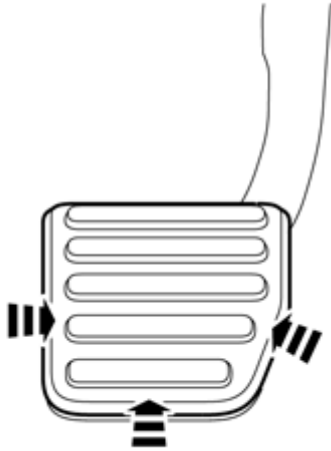

IMG-309671

9B

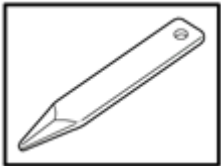
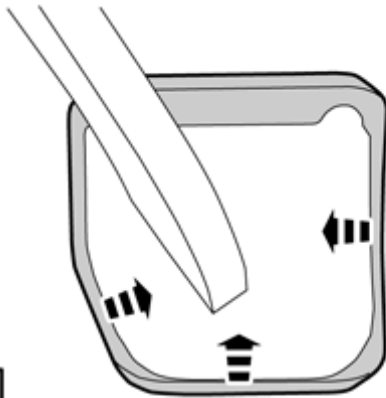

IMG-309803

A

Press the cover against the pedal at the same time as folding the cover's edges over using a weatherstrip tool.

Check, using a mirror, that the edges of the cover have covered the pedal. Pull at the cover to check that it is secure.

Repeat the steps for the clutch pedal.

B